

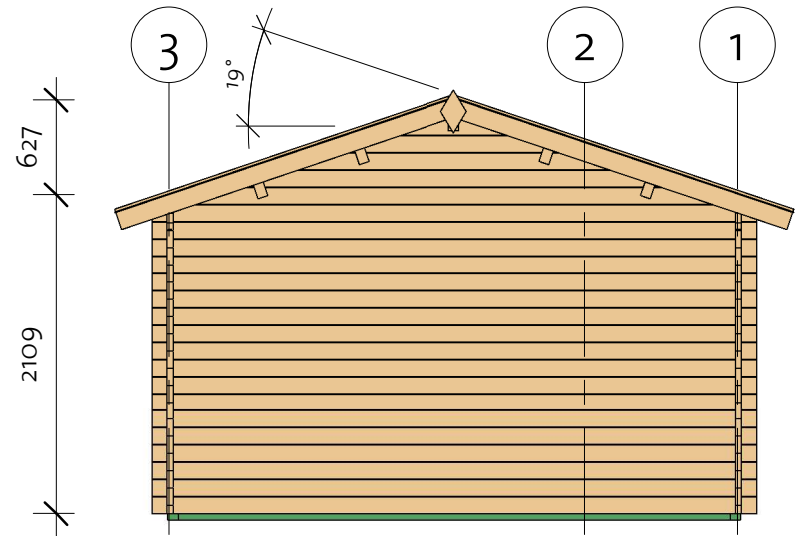

# Strüver 40 (510x380)

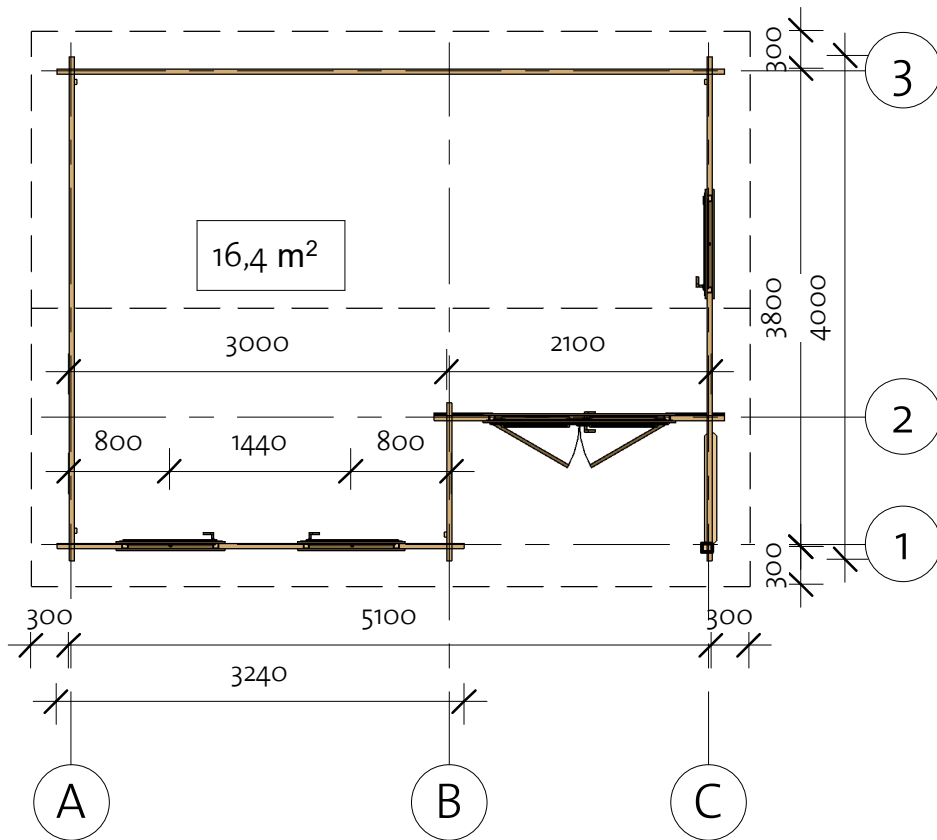
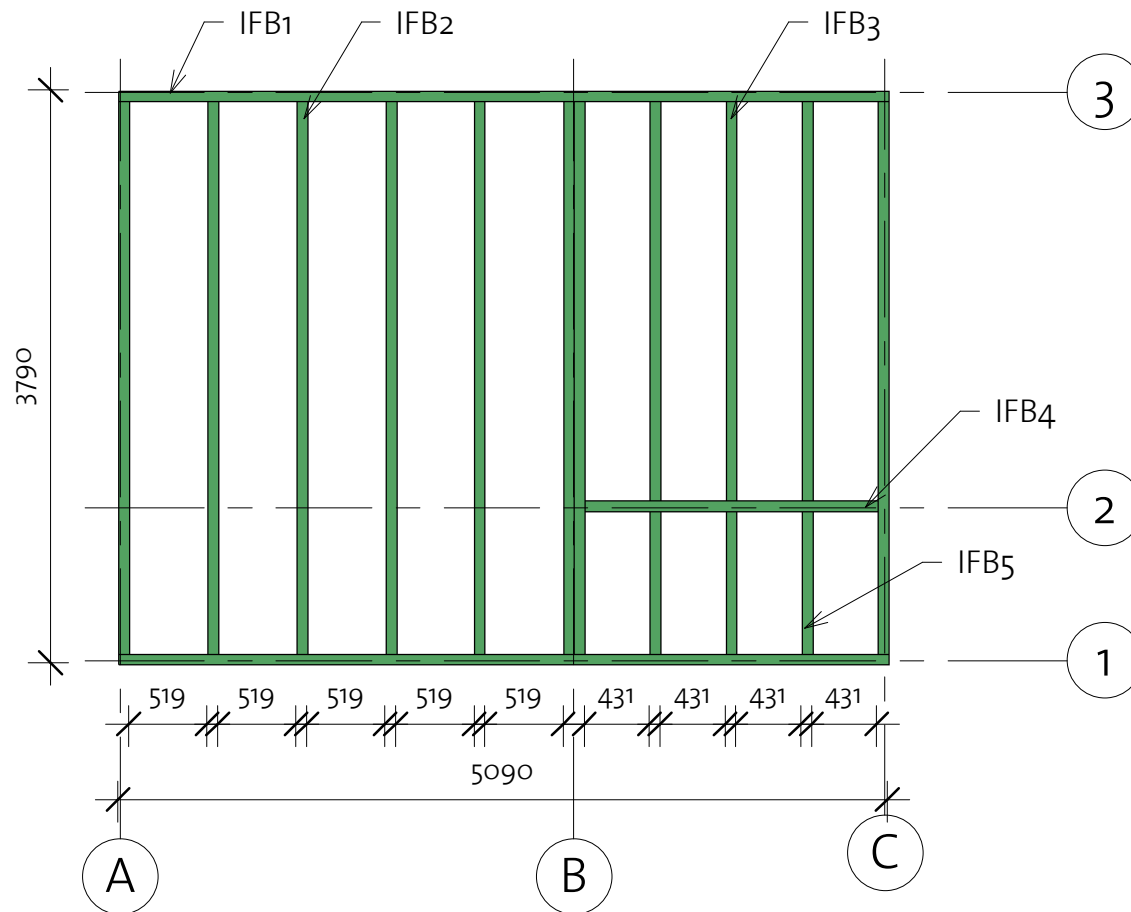

# Strüver 40 (510x380)

Foundation



Impregnated foundation beams				
Mark	Type	Profile	Count	Length
IFB1	IFB 70x40		2	5090
IFB2	IFB 70x40		8	3650
IFB3	IFB 70x40		3	2640
IFB4	IFB 70x40		1	1935
IFB5	IFB 70x40		3	940



# Strüver 40 (510x380)

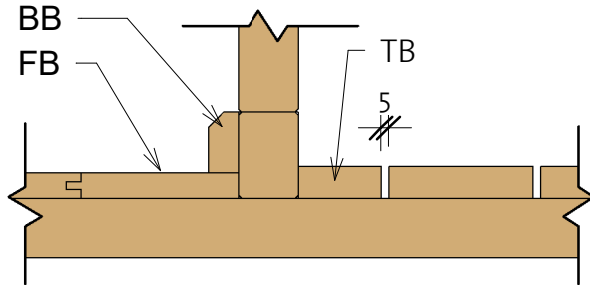

Floor Plan ① Baseboard



Floor Schedule

Mark	Type	Profile	Count	Length
------	------	---------	-------	--------

FB1	FB 17x114		25	5014
FB2	FB 17x114		10	2954
TB	TB 21x95		11	2052

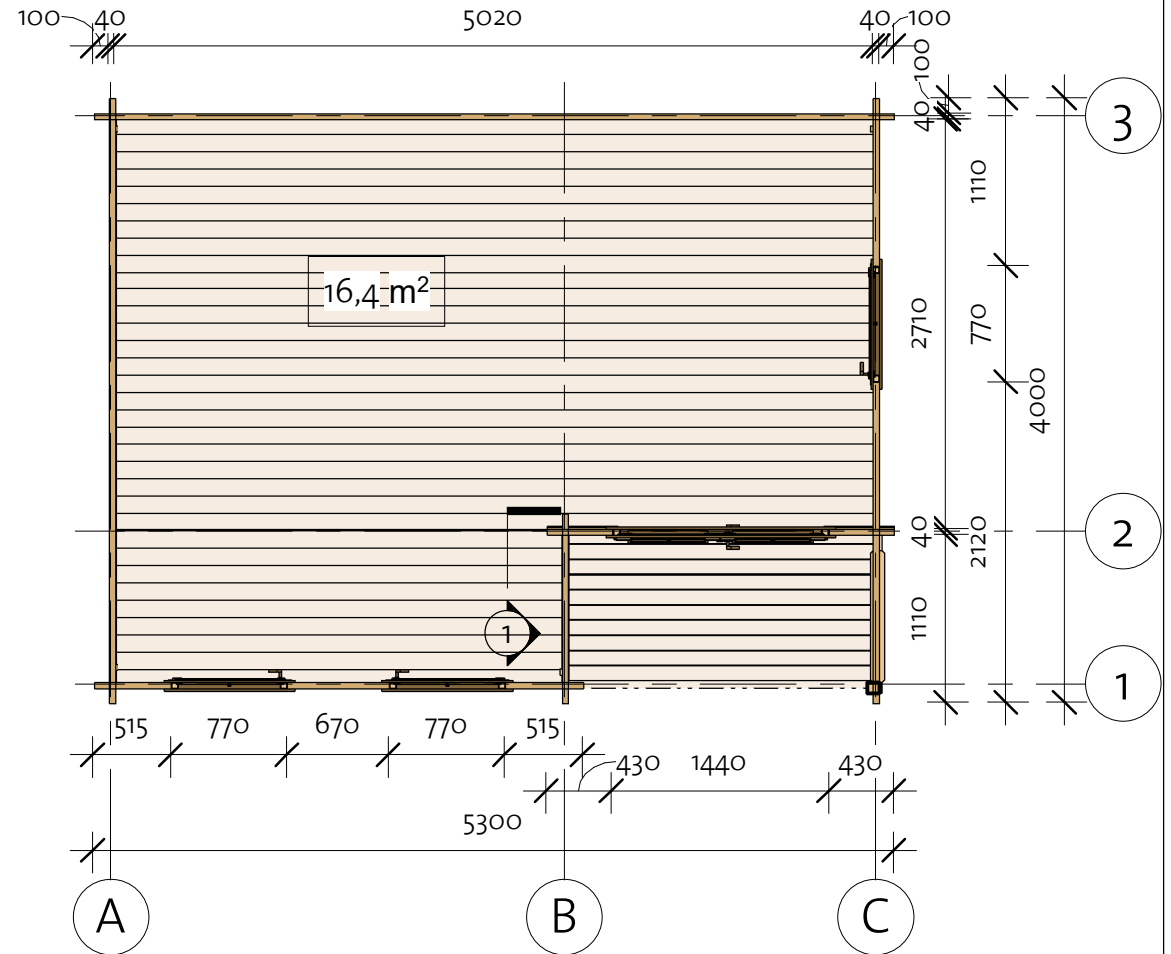

BB1	BB 20x40		2	5100
BB2	BB 20x40		2	3800



# Strüver 40 (510x380)

Wall 1

Log Profile Wall 1	
Profile	Profile

40x57	
40x114	

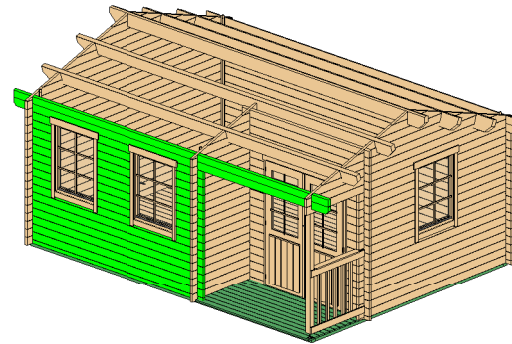

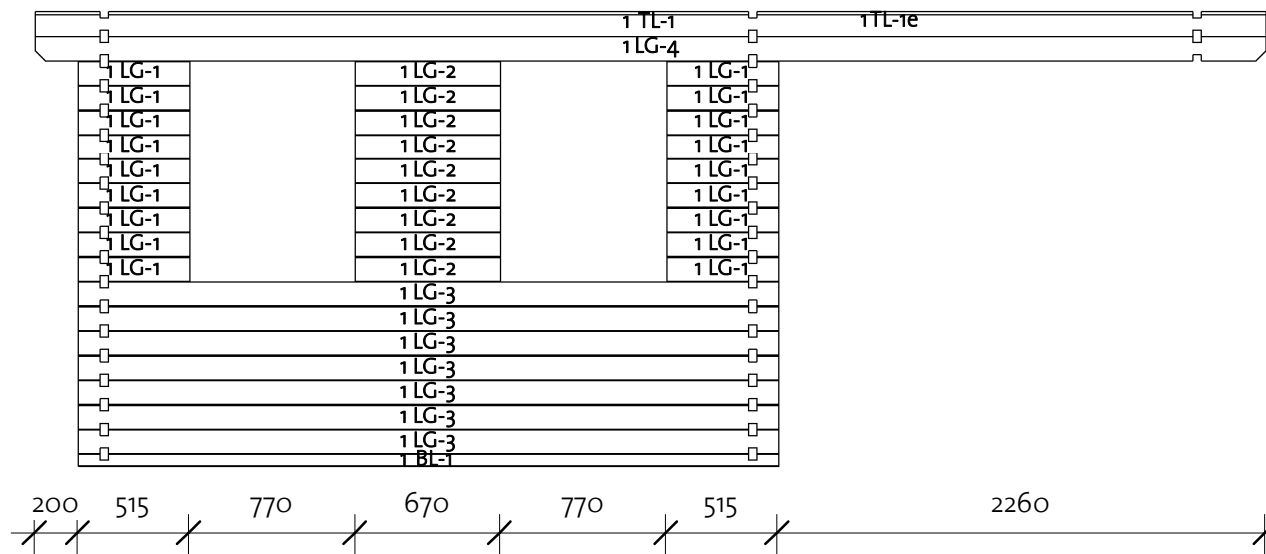

Wall 1			
Mark	Profile	Count	Cut Length

1BL-1	40x57	1	3240
1LG-1	40x114	18	515
1LG-2	40x114	9	670
1LG-3	40x114	7	3240
1LG-4	40x114	1	5700
1TL-1	40x114	1	5700
1TL-1e	40x114	1	5700



Log Profile Wall 1	
Profile	Profile

40x114	
40x114	

# Strüver 40 (510x380)

Wall 2

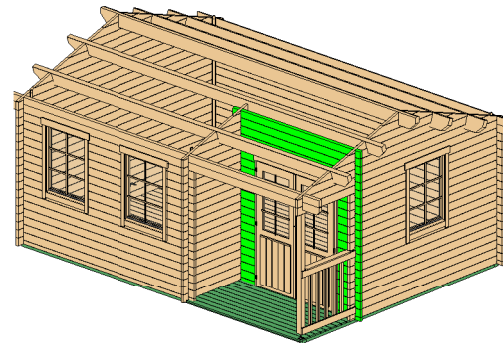

Wall 2			
Mark	Profile	Count	Cut Length

2BL-1	40X57	2	430
2LG-1	40X114	32	430
2LG-2	40X114	3	2300
2LG-3	40X114	1	2300
2TL-1	40X113	1	2300

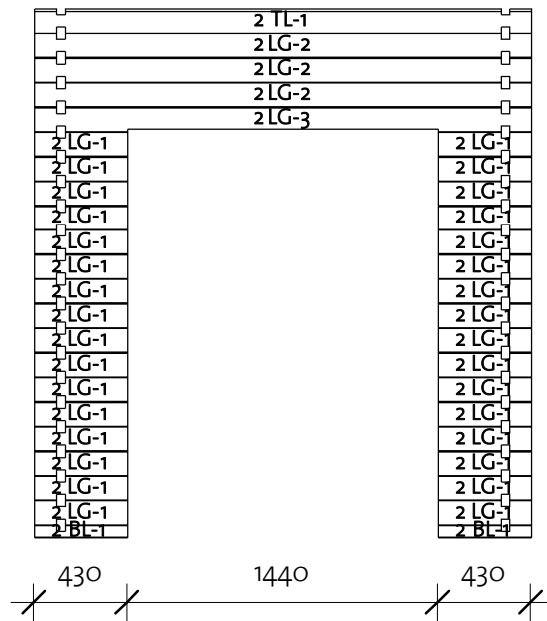

Log Profile Wall 2	
Profile	Profile

40X57	
40X113	
40X114	

# Strüver 40 (510x380)

Wall 3

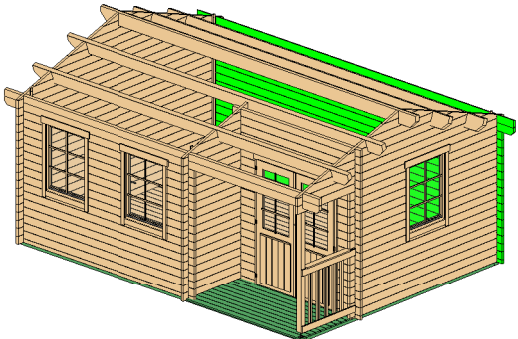

Wall 3			
Mark	Profile	Count	Cut Length

3BL-1	40x57	1	5300
3LG-1	40x114	16	5300
3LG-2	40x114	1	5700
3TL-1	40x114	1	5700

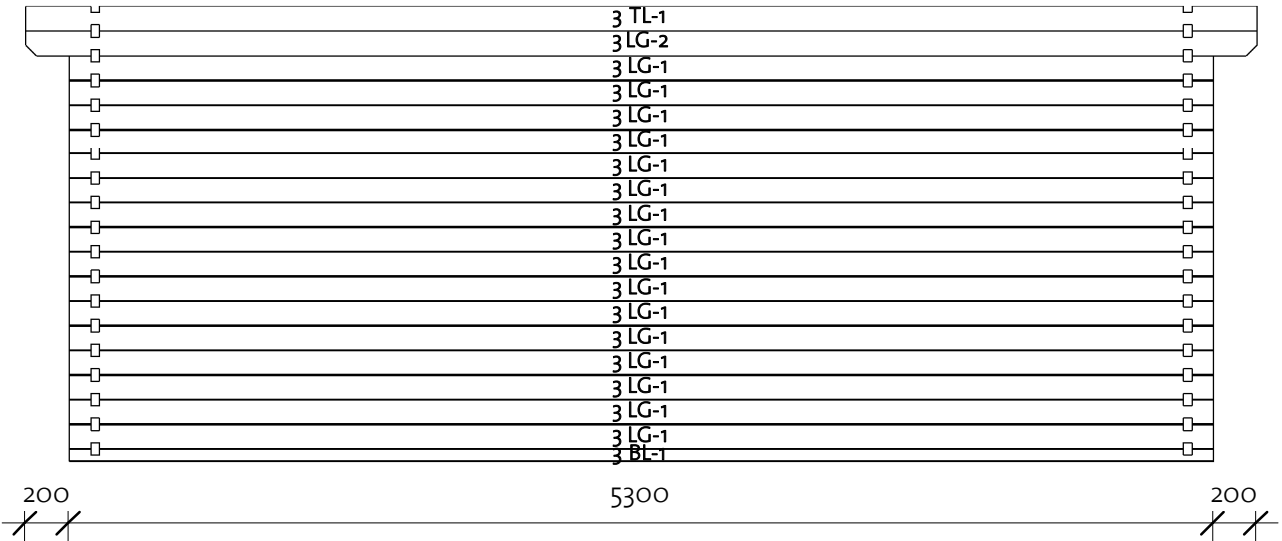

Log Profile Wall 3	
Profile	Profile

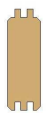
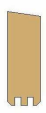
40x57	
40x114	
40x114	

# Strüver 40 (510x380)

Wall A

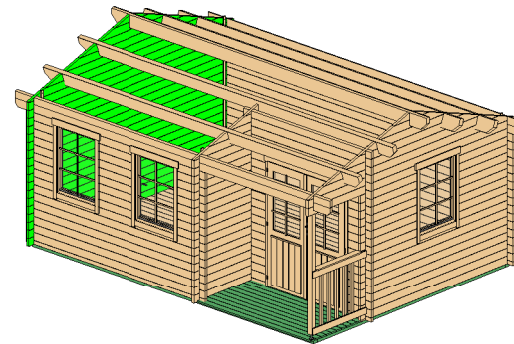

Wall A			
Mark	Profile	Count	Cut Length

ALG-1*	40X114	1	678
ALG-2*	40X114	1	1256
ALG-3*	40X114	1	2030
ALG-4*	40X114	1	2595
ALG-5*	40X114	1	3382
ALG-6*	40X114	1	4000
ALG-7	40X114	18	4000

\* Gable - delivered premounted

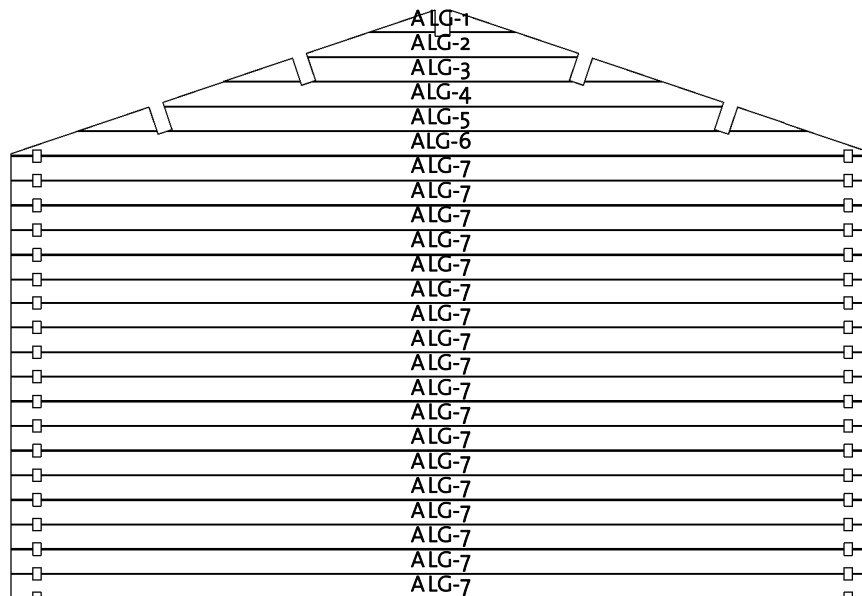

Log Profile Wall A	
Profile	Profile

40X114	
--------	--

# Strüver 40 (510x380)

Wall B

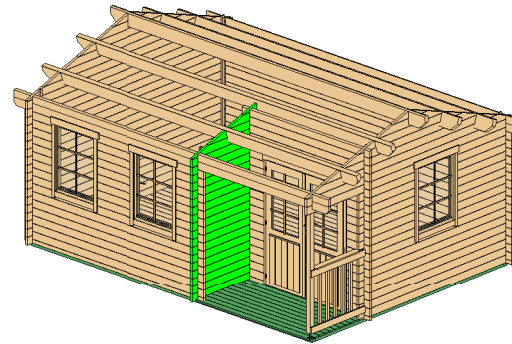

Wall B			
Mark	Profile	Count	Cut Length

BLG-1*	40X114	1	265
BLG-2*	40X114	1	547
BLG-3*	40X114	1	941
BLG-4*	40X114	1	1250
BLG-5	40X114	18	1250

\* Gable - delivered premounted

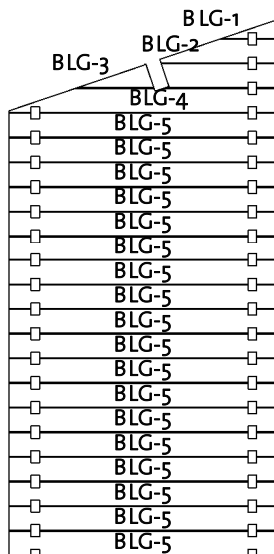

Log Profile Wall B	
Profile	Profile

40X114	
--------	--



# Strüver 40 (510x380)

Wall C

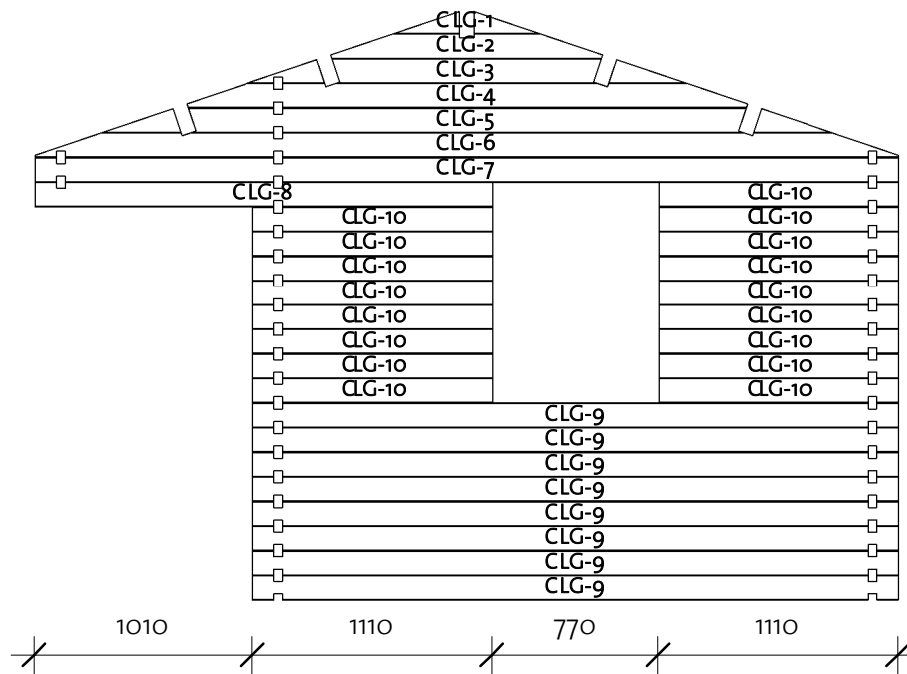
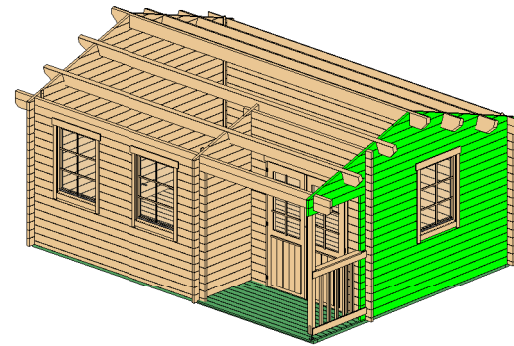

Wall C			
Mark	Profile	Count	Cut Length

CLG-1 *	40X114	1	678
CLG-2 *	40X114	1	1256
CLG-3 *	40X114	1	2030
CLG-4 *	40X114	1	2595
CLG-5 *	40X114	1	3382
CLG-6 *	40X114	1	4000
CLG-7	40X114	1	4000
CLG-8	40X114	1	2120
CLG-9	40X114	8	2990
CLG-10	40X114	17	1110

\* Gable - delivered premounted



Log Profile Wall C	
Profile	Profile

40X114	
--------	--

# Strüver 40 (510x380)

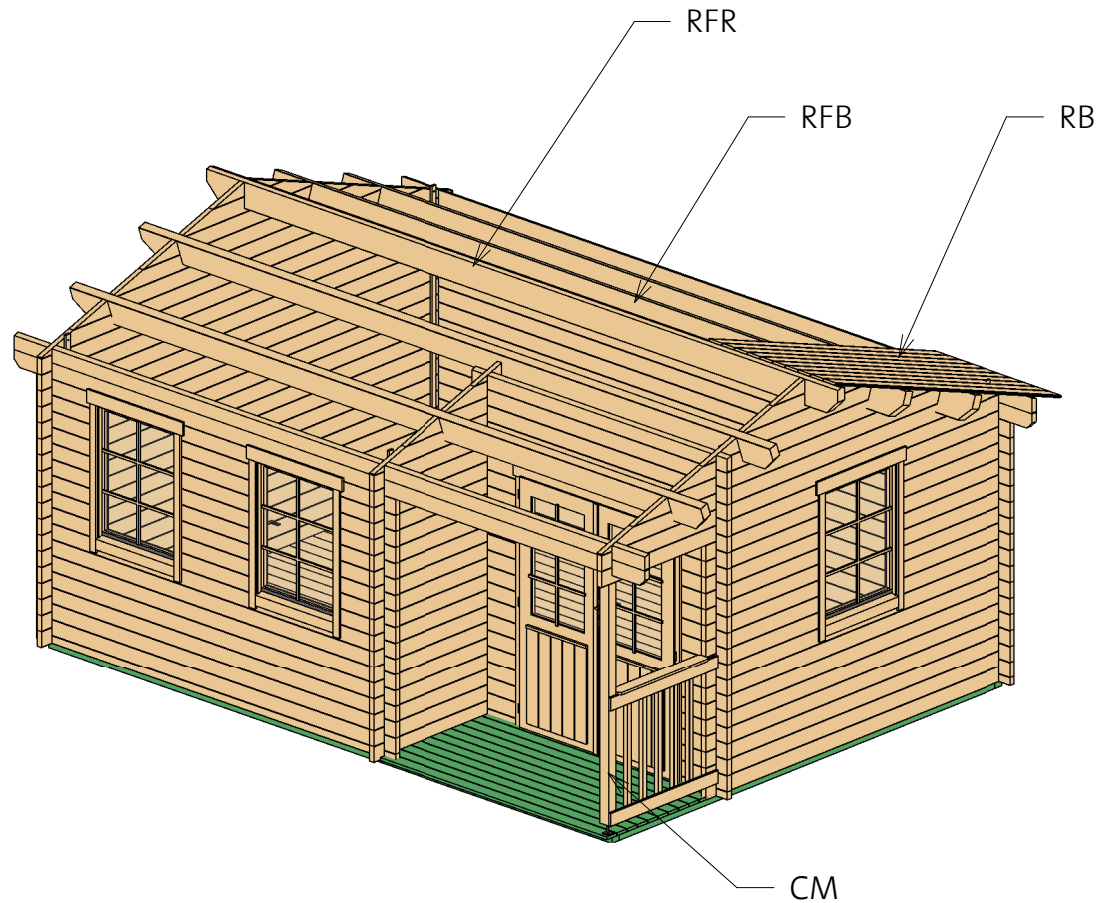
Roof 1



Roof				
Mark	Type	Profile	Count	Length
RFR	Ridge 68x198		1	5700
RFB	Beam 68x198		4	5700
RB	17x114		102	2316

Columns			
Mark	Profile	Count	Length
CM	Post 80x70	1	1785

# Strüver 40 (510x380)

Roof 2

② Fascia

Fascia Schedule				
Mark	Type	Profile	Count	Length

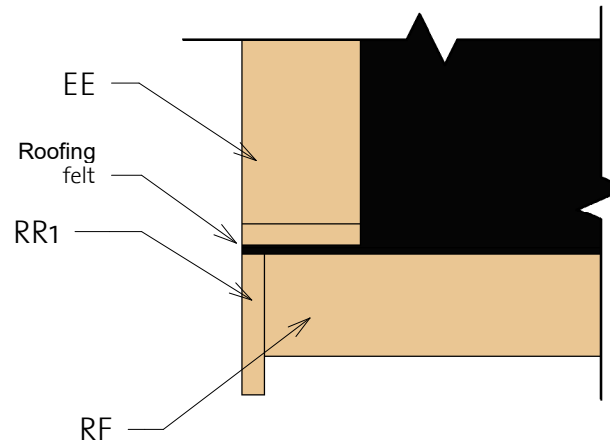
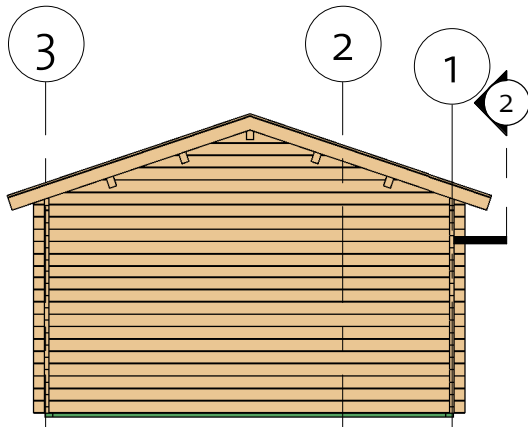

EE	Eave Edging 18x95		4	2362
RF	Roof Fascia 18x120		4	2362
RR1	Roof reinforcement 18x95		2	5700
RR2	Roof reinforcement 38x38		2	5700

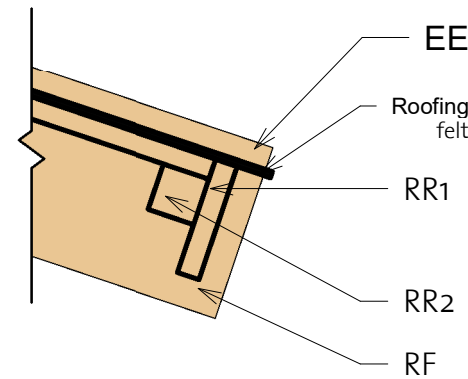
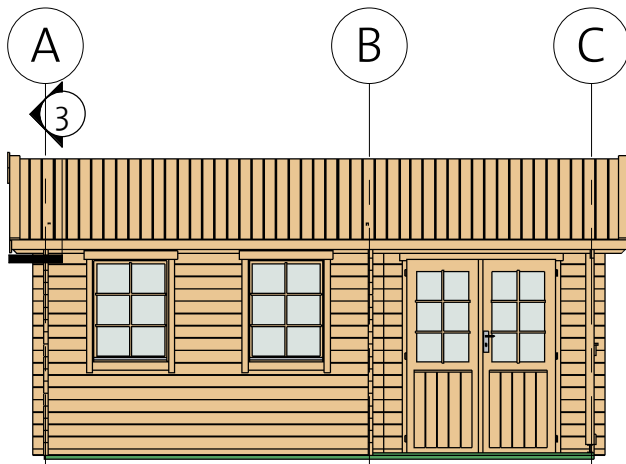

③ Roof reinforcement

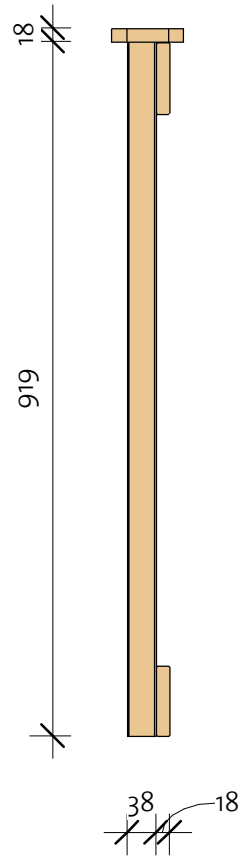
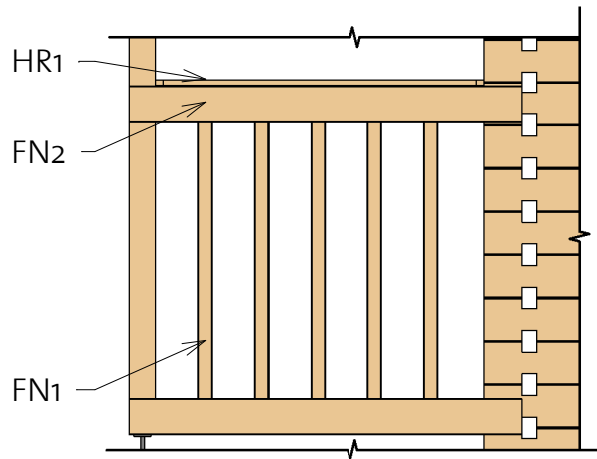

# Strüver 40 (510x380)

Fence

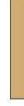

Fence schedule				
Mark	Type	Profile	Length	Count
FN1	Lath 38x38		919	5
FN2	Board 18x95		1040	2

Mark	Type	Profile	Count	Length
HR	18x95		1	870

# Strüver 40 (510x380)

Extras

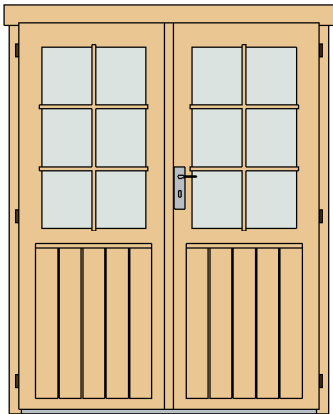

Door Schedule				
Model	Type	Width	Height	Count
CDD12R	Classic double door 12 right	1425	1835	1
DCB6	Door Crossbar 6	--	--	2
DB1	Door beam 1440 mm	40	12	1

Type	Count	Length
------	-------	--------

Windboard 18x40	4	2200
Windboard 18x40 2400	1	2400

Type	Count
------	-------

Romb	2
------	---



Name	Type	Count
------	------	-------

Hitblock	300-400 mm	
Adjustable post foot		1
Bolts	M8x70	15
Screws	5,0 x 70	30
Nails	1,4 x 40	45
Screws	6,0 x 140	75
Screws	4,0 x 40	100
Screws	4,0 x 50	950

Window Schedule				
Mark	Type	Width	Height	Count

CW1L	Classic window 1 left	765	990	2
CW1R	Classic window 1 right	760	990	1
WCB6	Windows Crossbar 6	--	--	3

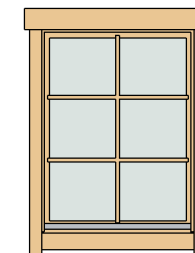

# Strüver 40 (510x380)

## List of all items 1



### Impregnated foundation beams

Mark	Type	Profile	Count	Length
------	------	---------	-------	--------

IFB1	IFB 70x40		2	5090
IFB2	IFB 70x40		8	3650
IFB3	IFB 70x40		3	2640
IFB4	IFB 70x40		1	1935
IFB5	IFB 70x40		3	940

### Roof

Mark	Type	Profile	Count	Length
------	------	---------	-------	--------

RFR	Ridge 68x198		1	5700
RFB	Beam 68x198		4	5700
RB	17x114		102	2316



### Columns

Mark	Profile	Count	Length
------	---------	-------	--------

CM	Post 80x70	1	1785
----	------------	---	------

### Floor Schedule





Mark	Type	Profile	Count	Length
------	------	---------	-------	--------

FB1	FB 17x114		25	5014
FB2	FB 17x114		10	2954
TB	TB 21x95		11	2052

BB1	BB 20x40		2	5100
BB2	BB 20x40		2	3800

### Fascia Schedule

Mark	Type	Profile	Count	Length
------	------	---------	-------	--------

EE	Eave Edging 18x95		4	2362
RF	Roof Fascia 18x120		4	2362
RR1	Roof reinforce ment 18x95		2	5700
RR2	Roof reinforce ment 38x38		2	5700

# Strüver 40 (510x380)

## List of all items 2

Wall 1			
Mark	Profile	Count	Cut Length

1BL-1	40x57	1	3240
1LG-1	40x114	18	515
1LG-2	40x114	9	670
1LG-3	40x114	7	3240
1LG-4	40x114	1	5700
1TL-1	40x114	1	5700
1TL-1e	40x114	1	5700

Wall 3			
Mark	Profile	Count	Cut Length

3BL-1	40x57	1	5300
3LG-1	40x114	16	5300
3LG-2	40x114	1	5700
3TL-1	40x114	1	5700

Wall A			
Mark	Profile	Count	Cut Length

ALG-1*	40x114	1	678
ALG-2*	40x114	1	1256
ALG-3*	40x114	1	2030
ALG-4*	40x114	1	2595
ALG-5*	40x114	1	3382
ALG-6*	40x114	1	4000
ALG-7	40x114	18	4000

Wall 2			
Mark	Profile	Count	Cut Length

2BL-1	40x57	2	430
2LG-1	40x114	32	430
2LG-2	40x114	3	2300
2LG-3	40x114	1	2300
2TL-1	40x113	1	2300

Wall B			
Mark	Profile	Count	Cut Length

BLG-1*	40x114	1	265
BLG-2*	40x114	1	547
BLG-3*	40x114	1	941
BLG-4*	40x114	1	1250
BLG-5	40x114	18	1250



Wall C			
Mark	Profile	Count	Cut Length

CLG-1*	40x114	1	678
CLG-2*	40x114	1	1256
CLG-3*	40x114	1	2030
CLG-4*	40x114	1	2595
CLG-5*	40x114	1	3382
CLG-6*	40x114	1	4000
CLG-7	40x114	1	4000
CLG-8	40x114	1	2120
CLG-9	40x114	8	2990
CLG-10	40x114	17	1110

\* Gable - delivered premounted

# Strüver 40 (510x380)

## List of all items 3

Fence schedule				
Mark	Type	Profile	Length	Count
FN1	Lath 38x38		919	5
FN2	Board 18x95		1040	2

Mark	Type	Profile	Count	Length
HR	18x95		1	870

Log profiles	
Profile	Profile

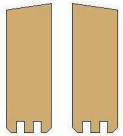
40x57	
40x114	

Log profiles	
Profile	Profile

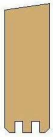
40x113	
40x114	